

### beautifully built and crated with care

It is our companywide pledge and never-ending ambition to have our products arrive at your jobsite in perfect condition.

To that end, doors and frames are meticulously wrapped in impact-absorbing materials and carefully packaged in heavy-duty wooden crates. We take every measure to ensure a smooth and timely arrival. If a problem does occur, rest assured we will do what we can to help make it right.

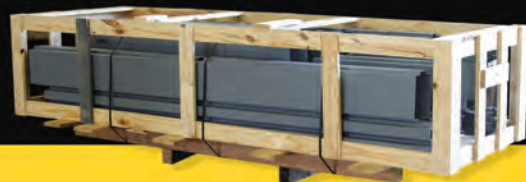

### The difference is quality.

There's no substitute for experience and hands-on product knowledge. NCHM has assembled a hard-working team through the years. Our people truly make the quality difference.



### quikship

- Doors:**
- Stainless Steel
- Galvanneal
- Polystyrene
- Steel Stiffened
- Lead Lined
- Arched
- Fire Rated

- Frames:**
- Stainless Steel
- Galvanneal
- Lead Lined
- Pocket Door
- Arched
- Stainless Spats
- Fire Rated

ready for you.

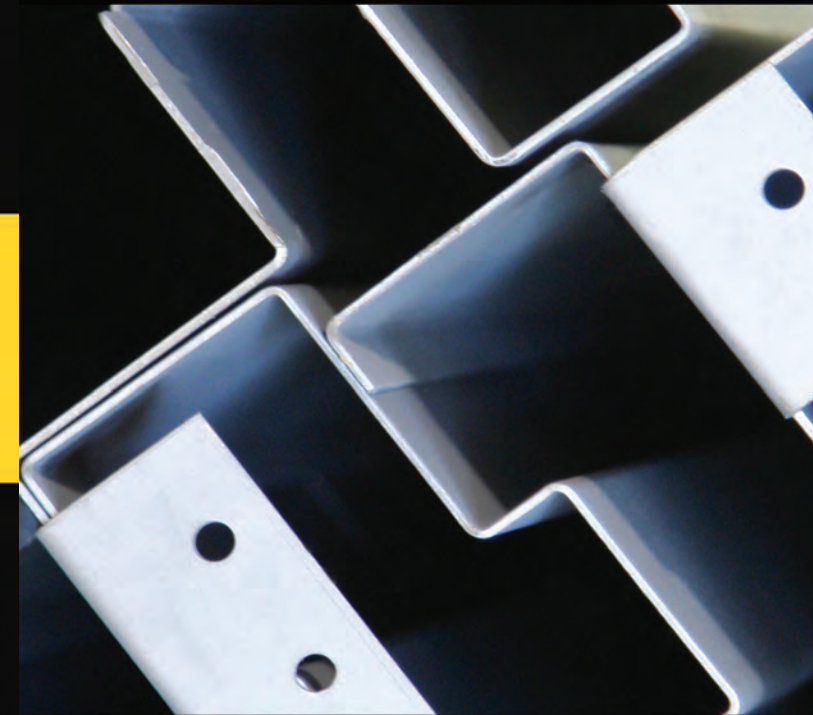

# NATIONAL

CUSTOM HOLLOW METAL DOORS & FRAMES

The distinction is in the details.

# NATIONAL

CUSTOM HOLLOW METAL DOORS & FRAMES

1701 East 22nd Street, Little Rock, Arkansas 72206  
800.334.3070

ph: 501.372.3441  
fx: 501.375.3070

[nationalcustomhollowmetal.com](http://nationalcustomhollowmetal.com)  
© 2007, National Custom Hollow Metal Doors & Frames

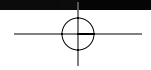



Pride in our work and a drive for perfection translate into products of superior form, fit and function—as well as a higher level of consistent quality and cost efficiency.

# NATIONAL

CUSTOM HOLLOW METAL DOORS & FRAMES



Start smart. Finish strong.

Evan Mathews, Vice President of Operations (left), and Shea Mathews, Vice President of Sales and Marketing, carry on NCHM's long-standing tradition of quality with a sharpened focus on continuous product improvement and quick turnaround time.

National Custom Hollow Metal Doors & Frames offers an extensive range of custom-crafted cold-rolled, stainless steel and galvanized metal doors and frames to accommodate your project planning and expedite your building schedule. Whether destined for heavy-duty industrial environments, hospitals and laboratories, restaurants or storefronts, our doors are expertly crafted to precise tolerances and exact specifications out of materials specifically chosen to ensure superior durability, appearance and ease of operation.

Size, shape and short lead times are never an issue. With precision engineering, rigorous testing and time-honored workmanship we'll turn your ideas and designs into doors and frames of superb quality.

So much more than a door. A higher level of craftsmanship and attention to detail. Superior products and outstanding service. Industry-leading turnaround time for custom orders. The dedication to meet every customer's needs, every day.

At National Custom Hollow Metal Doors & Frames, we give you much more than doors.

- **The confidence** that under our watchful eyes and skilled hands every door and frame is built to stand strong, fit with precision, and provide years of excellent service.
- **The promise** that from raw materials through production, our products are rigorously tested and inspected to meet or exceed industry standards for structural integrity and performance.
- **The trust** that our doors and frames are backed by the full faith of our more than four decades of industry expertise.

Under the ownership of the Mathews family, our long-standing tradition of excellence continues as the cornerstone of our success. When it comes to choosing the best source for all your custom-built and pre-engineered steel doors and frames, you can depend on NCHM for exceptional quality, service and value.

## Tested and true.

NCHM proudly offers cold-rolled, galvanized and DEFENDDOOR – stainless steel doors and frames, constructed to conform to Commercial Standard CS242-62, Product Standard PS4-66 and Federal Specification RR-D-575C. They are fabricated from premium-quality cold-rolled steel in accordance with ASTM A366, or galvanized steel in accordance with ASTM A525, or stainless steel in accordance with ASTM A240.



## door&frametypes

### LABELED DOOR TYPES

Our extensive door product line includes Certified labeled products manufactured in strict accordance with the specifications and procedures as determined by Underwriters Laboratories or Warnock Hersey International testing and inspecting services. Certified labeled doors meet every requirement for fire protection and are labeled accordingly:

- A Label = 3 Hours**
- B Label = 1-1/2" Hours**
- C Label = 3/4 Hour**
- 20 Minute Label**

### Single

Door Series	Max. Size	Label Available
DS-416	4'0" x 10'0"	A, B, C, 20 min
DP-416	4'0" x 8'0"	B, C, 20 min
DP-418	3'10" x 8'0"	B, C, 20 min

1-3/8" doors can be labeled up to 45 min. Maximum size of 3072. Door must be 16 gauge steel stiffened.

### Pair

Door Series	Max. Size	Label Available
DS-416	4'0" x 10'0"	A, B, C, 20 min
DP-416	4'0" x 8'0"	B, C, 20 min
DP-418	3'10" x 8'0"	B, C, 20 min

### Louwer

Door Series	Max. Size	Label Available
DS-416	4'0" x 8'0"	B, C, 20 min

Fusible link louver required. Maximum louver size: 24" x 24". Glass lites or fire exit hardware is not approved.

### Double Egress Doors and Frames

Door Series	Max. Size	Label Available
DS-416	8'0" x 8'0"	B, 20 min

Frame gauge: 16 and 14. Jamb depth: 5" min. - 14" max. Vertical rod exit devices required on each leaf. Welded-on astragal required. 100 square inches of exposed glass permitted per leaf.

### Stainless Doors – DEFENDDOOR

Door Series	Max. Size	Label Available
DH-416	3'4" x 8'0"	A, B, C, 20 min
DH-416	6'8" x 8'0"	A, B, C, 20 min

DEFENDDOOR is a national brand of stainless doors and frames manufactured by NCHM, right here in the U.S.A. Each unit is custom manufactured to achieve a flawless appearance and deliver outstanding performance and lasting value.

### FRAME TYPES

NCHM produces a variety of frames to meet every application, allowing maximum design flexibility without compromising strength and structural integrity.

### Stainless Steel

High-performance stainless steel frames are available as standard and custom openings, borrowed lites, side lites and transom frames. Stainless hollow metal frames are formed of 16 gauge or 14 gauge, Type 304 or 316 stainless, No. 3, 4 or 2b mill-finish stainless steel.

### Variable

"Easy" describes our variable frame assembly process. A unique interlocking mitered corner joint creates a quick, clean connection in seconds. Simply insert jambs into the header and bend tabs over to secure the assembly.

Frame Series	Thickness	Gauge Steel
S-416	1-3/4"	16
S-414	1-3/4"	14
S-412	1-3/4"	12

UL, WHI and Certified labels are available. Lead lining of frames is available where required.

### Stick

Ideal for fabricating complete frame assemblies on location. Furnished blank or with provisions ready for hardware. Simple, reliable and time-efficient!

Frame Series	Thickness	Gauge Steel
FS-416	1-3/4"	16
FS-414	1-3/4"	14
FS-412	1-3/4"	12

### Drywall

Our unique Surlock Drywall Corner Connection makes frame installation fast and neat. Frame can be installed after dry walling is complete in as little as four minutes.

Frame Series	Thickness	Gauge Steel
D-416	1-3/4"	16
D-414	1-3/4"	14

### Stainless Frames – DEFENDDOOR

NCHM's DEFENDDOOR stainless hollow metal frames are available as standard and custom openings, borrowed lights, side lights and transom frames.

### Pocket Door

Pocket door frames create an elegant, clean-line design for walls and floor areas with space-saving requirements. A variety of sizes can be custom-crafted to meet your design specifications.

### Arched Doors and Frames

Classically styled and powerfully built, NCHM's arched doors and frames are superbly crafted for enduring beauty and performance. Choices include products made from stretch-formed, premium-quality cold-rolled steel, galvanized steel or stainless steel. Removable glass stops to match the curvature of frame are factory pre-fit for the glass thickness required in all areas where glass is to be field-installed. Factory pre-fit arched doors are also available to match curvature of frame.

### Stainless Spats

Stainless steel spats facilitate easy cleaning of the door frame and provide a protective layer from corrosive chemicals or other elements that can harm typical galvanized or cold-rolled steel frames. Stainless spats are available from 4" up to the full frame height.

### Labeled Three-Sided Frames

Frame Series	Max. Size	Label Available
S-416	4'0" x 10'0"	A, B, C, 20 min
S-416	8'0" x 10'0"	A, B, C, 20 min
S-414	4'0" x 10'0"	A, B, C, 20 min
S-414	8'0" x 10'0"	A, B, C, 20 min
D-16	4'0" x 9'0"	B, C, 20 min
D-16	8'0" x 9'0"	B, C, 20 min
D-14	4'0" x 9'0"	B, C, 20 min
D-14	8'0" x 9'0"	B, C, 20 min

### Also Available:

- Transom panel frames without bar
- Transom frames with bar and metal panel
- Transom frames with bar and glazing bead
- Multiple opening frames with transom panel or lites and/or side panels or lites
- 3/4-hour borrowed lite frames
- 20 minutes without hose stream borrowed lites
- 20 minutes without hose stream side-lite frames
- Labeled frames for total doors/openings included

**builtstronger**

Straight out, our customers tell us that our doors seem stronger and more durable, and that they just feel like they're going to last longer. The fact that much of our manufacturing process is handcrafted and hand-welded makes for a better door. When you compare NCHM doors with the competition, you'll see—and feel—the quality difference.

*Doors are compressed with 100 pounds of pressure to ensure proper lamination and a flat, uniform surface.*

**customdoors:**



- Stainless Steel**
- Galvanneal**
- Polystyrene**
- Steel Stiffened**
- Lead Lined**
- Arched**
- Fire Rated**

*Choose from a wide variety of standard door designs available in 18, 16, 14, 12 gauge galvanneal steel and type 304 or 316 stainless steel with either polystyrene or vertical steel stiffened cores.*



**standardprofiles:**

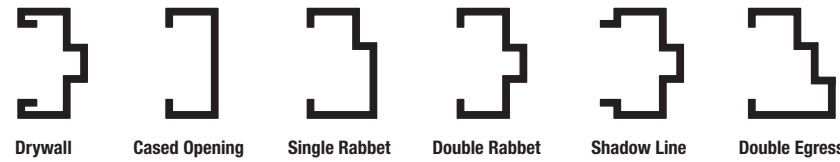

**customframes:**

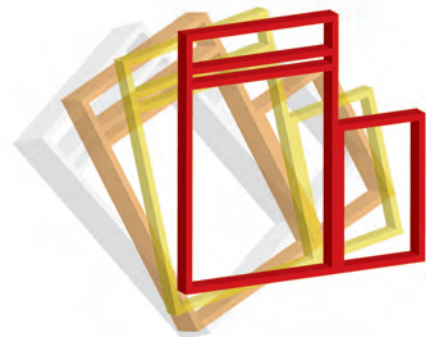

- Stainless Steel**
- Galvanneal**
- Lead Lined**
- Pocket Door**
- Arched**
- Stainless Spats**
- Fire Rated**

*Custom or complex frame designs can be furnished as welded or shipped knocked-down for field or shop welding.*

**our expertise...your advantage**

Customers have questions, and we have more than just textbook answers. Our highly knowledgeable and friendly staff offers the specialized insight only experience can offer. When a customer calls to order a door or frame, we talk about the specific requirements and help them choose the best product for the job. And while we strive to innovate and advance our products, nothing excites us more than giving our customers exactly what they need.



**doorcores:**

**Polystyrene** – With safety and insulating performance in mind, self-extinguishing polystyrene panels are used to fill the door cavity. This high-density layer of insulation provides superior resistance to the transfer of heat and cold, and also serves as a sound-deadening barrier to achieve quiet comfort in your environment.

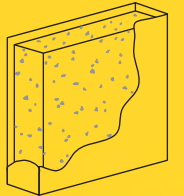

*CNC gauging on this Pacific 225 Tone Press Brake ensures that dimensions and shapes are formed to exact specifications.*

*Corners can be supplied face welded and ground smooth or full depth welded and ground smooth.*

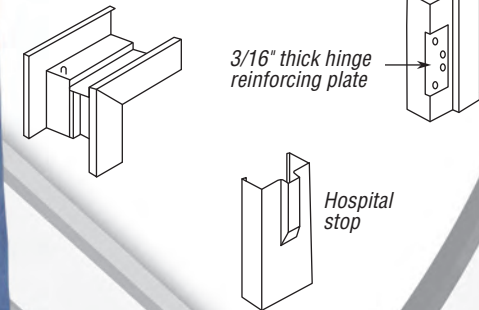

**Steel Stiffened** – Performance-engineered 22-gauge vertical hat-shaped steel stiffeners and facings are spot-welded on 6" centers to create a rugged door that can stand up strong to everyday impact. An excellent choice for schools, factories, hospitals and other high-traffic applications.

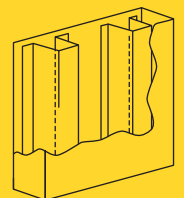

**Lead Lined** – Lead-lined doors feature a continuous sheet of lead centered between two panels of high-density polystyrene. The lead sheet extends the full width and height of the door and is centered in the door. Lead-lined frames also are available in the same material as doors, and both doors and frames can be labeled up to 1-1/2 hour with maximum thickness of 3/32".

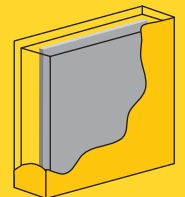

*NCHM doors and frames meet or exceed nationally recognized and accepted test standards and criteria. Using independent testing and certification agencies, our products earn consistently high marks for quality and performance.*



Our expert craftsmen assemble and weld typical frames as well as borrowed lite, side lite, and elaborate window wall frames to exacting dimensions.



**qualitycomponents**

**No Part Goes Unnoticed!** Because every facet of our door and frame construction contributes to overall product performance, we incorporate only quality-proven components to finish the job.

**Corners** – Corners can be supplied face-welded and ground smooth, or full-depth welded and ground smooth.

**Reinforcements** – Mortised hardware items are drilled and tapped at the factory. Reinforcements for surface-applied hardware will be drilled and tapped in the field by the contractor. All reinforcing components are stainless steel.

**Weld Types** – Frame assemblies are shipped to the jobsite completely welded. Field joints are permitted when the size of the total assembly exceeds shipping limitations, materials limitations, or restricted access for installation.

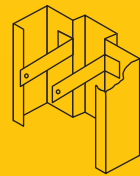

Wood Stud Clip

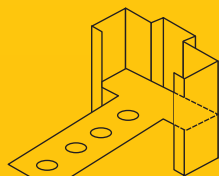

Masonry T

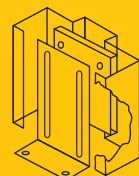

ADJ FL Clip



Welded Floor Clip

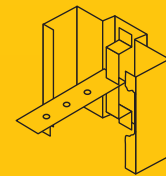

ADJ Loop Anchor



EOC Bolt Spacer



Channel Stud "Z" Clip

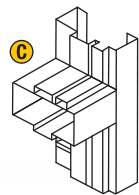
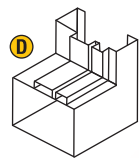
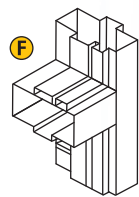
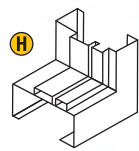

NCHM is a substantial departure from your ordinary door and frame manufacturer.

As a small, family-owned company, we do things a little differently. From the day you place your order to the day your product is shipped, every employee's hands and eyes are involved in the production process to make certain your product is in top condition. We will get to know you, your business, and how we can best serve your needs. With a mixture of industry insight and people energy, we will strive not only to satisfy you—but to make you happy.

**Let NCHM quote your next project!**

Call 501.372.3441 or 1.800.334.3070,  
or fax 501.375.3070.



**quikship**

When you need it now and need it right—Quik Ship is the answer. We can turn around orders for any typical size door or frame in 5 - 10 days, a significant time savings compared to the 6 or 8 weeks lead time required by many larger manufacturers.

**Section Details of Typical Welded Assemblies**

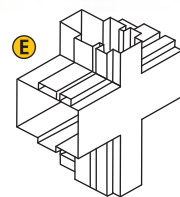
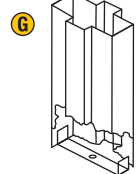
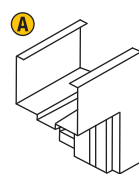
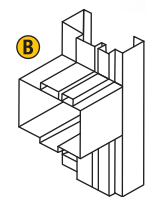
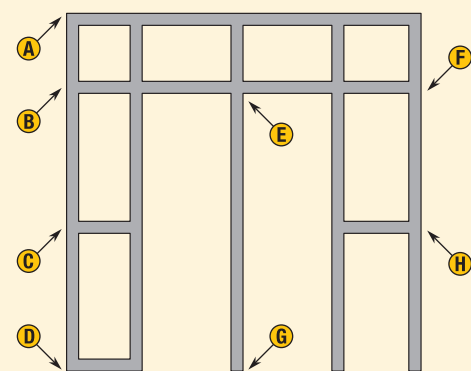

**Anchors** – Frames are furnished with a minimum of six proper anchors of manufacturer's standard design as required by wall conditions. Frames have sill anchors welded to the bottom of all jambs for attachment to the finished floor.

**NATIONAL**  
CUSTOM HOLLOW METAL DOORS & FRAMES



**hotrush**

For those critical times when you are in a bind, we answer the call with unmatched performance power. We will walk your order through our production facility and get it to you in record time.

**We listen. We build. We deliver—fast.**